

## 1. 适用范围 / SCOPE

此规格书是温度保险丝 TB 型系列，适合用于一般电化产品、电热器产品、厨房机器、电动机及线圈类…产品。

This specification applies to thermal cutoff : TB Series, which use in electrochemical product、electric heater、kitchen equipment、power equipment and coil product.

## 2. 产品型号 / TYPE

例「example」：



- ① 系列號 / Series Number
- ② 額定動作溫度 / Rated Functioning Temperature
- ③ 額定電流 / Rated Current
- ④ 額定電壓 / Rated Voltage
- ⑤ 認證符號 / Approved Symbol

## 3. 额定电流、额定电压及温度规格 / RATED CURRENT, RATED VOLTAGE AND TEMPERATURE TYPE

3-1 额定电流 / Ampere Rating: 2A

3-2 额定电压 / Voltage Rating: 250V AC

3-3 额定动作温度 / Rated Functioning Temperature ( $T_F$ )

最高极限温度 / Maximum Temperature Limit ( $T_M$ )

最高维持温度 / Holding Temperature Limit ( $T_H$ )

实际动作温度 / Cut-off Temperature

见下表 / See Table:



型号 Type No.	额定动作温度 TF.Tf (°C) Rated Functioning Temperature	实测动作 温度(°C) Cut-off Temperature	最高维持温度 TH.TC (°C) Holding Temperature Limit	最高极限温度 TM.Tm (°C) Maximum Temperature Limit	电气额定值 Electrical Ratings		安规认证符号 Safety approval mark
					电流(A) Current	电压(V) Voltage	
TB102	102	97±2	76	180	2A	250V	
TB115	115	112±3	85	180	2A	250V	
TB125	125	121±3	97	180	2A	250V	
TB130	130	126.5±3	102	180	2A	250V	
TB150	150	146±2	120	180	2A	250V	

#### 4. 標示 / MARKING

溫度保險絲上需有下列標示 / The Thermal Cutoffs shall have the following marking:



- ① 製造工廠的標識 / Manufacture's Logo: 
- ② 型號 / Type: TB
- ③ 額定動作溫度 / Rated Functioning Temperature( $T_F$ ): \_\_\_\_ °C
- ④ 額定電流 / Ampere Rating(A) : 2A
- ⑤ 額定電壓 / Voltage Rating(V) : 250V~
- ⑥ 批號 / Date Code : XX
- ⑦ 認證符號 / Approval Marks :  

注意 / NOTE: 對標示的大小和位置沒有規定 / Size and position of the markings shall not be provided.

#### 5. 外觀及形狀 / APPEARANCES AND CONFIGURATION

5-1 外觀不應有顯著的污點、鐵銹或裂紋；標示應該容易辨識。

There shall not be any remarkable stain, rust or crack on the appearances; marking shall be easily legible.

5-2 形狀：帶直線引腳的溫度保險絲。

Configuration: Radial Leaded Thermal Cutoffs.

#### 6. 工程圖和結構 / OUTLINE DRAWING AND STRUCTURE

6-1 工程圖（單位：mm） / Outline Drawing and Dimensions (Unit: mm)

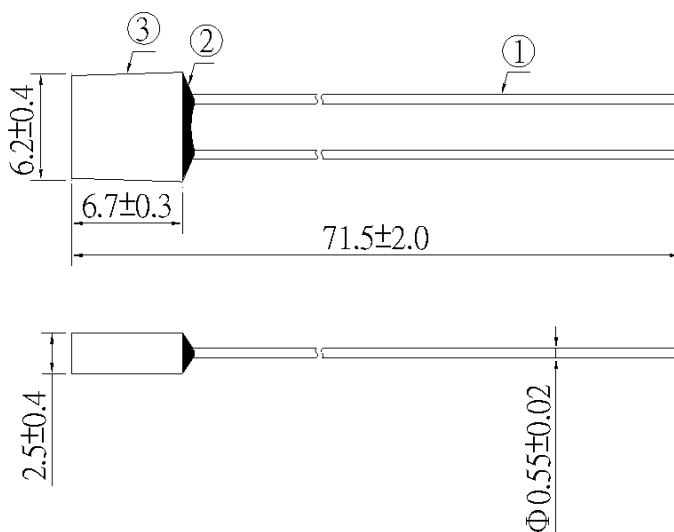

## 6-2 结构 / Structure

编号 No.	组件 Component	材质 Material	数量 Quantity
1	引线 Lead	镀锡铜线 Tin Plated Copper	2
2	封口树脂 Sealing Resin	环氧树脂 Epoxy Resin	~
3	外壳 Casing	塑料 Plastics	1

**7. 产品特性 / PRODUCT CHARACTERISTICS**

## 7-1 拉力 / Pull

温度保险丝样品以任何不致伤害到它的方便方式支撑起来，用 4.75N 的拉力作用到每一只引线脚上达 1 分钟，每只引线脚都不能断裂或松开。

The thermal cutoff is to be supported in any convenient manner so as not to damage it and a pull force as 4.75N to each lead for 1 minutes.

## 7-2 推力 / Push

温度保险丝样品以任何不致伤害到它的方便方式支撑起来，用 1.18N 的推力作用到每一只引线脚上达 1 分钟，每只引线脚都不能断裂或松开。

The thermal cutoff is to be supported in any convenient manner so as not to damage it and a push force as 1.18N to each lead for 1 minutes.

## 7-3 扭转力 / Twist

温度保险丝样品以任何不致伤害到它的方便方式支撑起来，在每一只引线脚上距离温度保险丝本体 10 mm 的地方折一个 90 度角，然后照下图所说明的样子扭转 180 度，每只引线脚都不能断裂或松开。

The thermal cutoff is to be rigidly supported so as not to damage it. Each lead is to be bent through 90 degrees at a location 10 mm from the body of thermal cutoff and then twisted through 180 degrees.

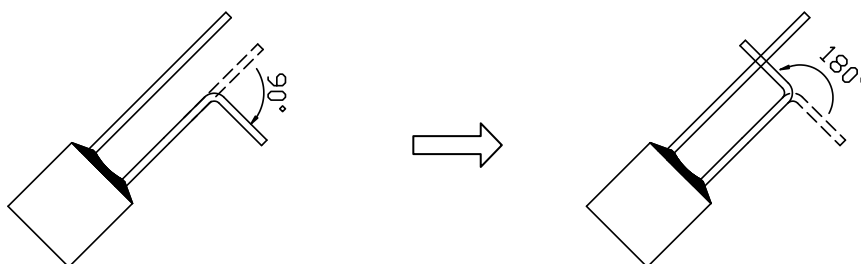



## 8. 溫度特性 / TEMPERATURE CHARACTERISTICS

### 8-1 額定動作溫度 (TF.Tf) / Rated Functioning Temperature

當僅有不大于 10 mA 的偵測電流作為負載的情況下，使溫度保險絲改變其導電狀態之溫度，此溫度公差在 +0, -10° C 範圍以內。

The temperature at which a thermal cutoff changes its state of conductivity to open a circuit with detection current of 10mA or less as the only load .The temperature tolerance is +0,-10° C.

### 8-2 實際動作溫度 / Cut-off Temperature

溫度保險絲在以升溫速率為 0.5~1° C/min，且以不高于 10mA 的偵測電流偵測烤爐中動作時的溫度。

Cut-off temperature is the actual operating temperature range when the thermal cutoff is made to operate inside a constant temperature oven whose temperature is raised at the rate of 0.5 to 1° C/min, while a detection current of 10mA or lower is applied.

### 8-3 保持溫度 (TH.Th.TC) / Holding Temperature

在溫度保險絲中，通以額定電流能夠連續維持 168 小時導通狀態，在此情況下，溫度保險絲所能夠承受的不致改變電氣導通狀態的最高溫度。

The maximum temperature at which a thermal cutoff can be maintained while conducting rated current for 168 hours without functioning.

### 8-4 最高極限溫度 (TM.Tm) / Maximum Temperature Limit

溫度保險絲所能處在的最高溫度，在這個高溫狀態下，溫度保險絲已改變其電氣導通性，溫度保險絲在這個高溫持續達 10 分鐘而不致破壞其機械性能和電氣特性。

The maximum temperature at which mechanical and electrical properties of a thermal cutoff can be maintained for 10 minutes without resuming conductivity after functioning.

### 8-5 存儲條件 / Storage Conditions

溫度 / temperature : -10°C ~ 40°C

相對濕度 / Humidity : 75% 以下 (年平均)，在無露水的情況下，保存 30 天的最大相對濕度為 95%。

Relative humidity  $\cong$  75% yearly average, without dew, maximum value for 30 days -95%.

## 9. 电气特性 / ELECTRICAL CHARACTERISTICS

### 9-1 绝缘阻抗 / Insulation Resistance

以额定电压值两倍的直流电压为测量电压，断开点之间的绝缘阻抗至少要有  $0.2M\Omega$ ；断电的通路点与外壳之间的绝缘阻抗至少要有  $2M\Omega$ 。

The insulation resistance is to be measured with a DC Voltage of twice the rated voltage, and at least  $0.2M\Omega$  across the disconnection; current path and the enclosures is not less than  $2M\Omega$ .

### 9-2 耐高电压测试 / Dielectric Voltage-Withstand Test

温度保险丝断电的通路点之间，可承受两倍额定电压值 1 分钟以上；温度保险丝带电部件与外壳之间，可承受两倍额定电压+1000V 1 分钟以上。

A thermal cutoff shall withstand double the rated voltage for 1 minute without breakdown; Live parts and enclosure  $2U_r+1000V$  for 1 minute without breakdown.

## 10. 安装方式及条件 / INSTALLATION WAY AND PARAMETERS

温度保险丝在使用、加工处理或安装时，请特别注意以下几点：

Please pay attention to the following notices when the thermal cutoff is used.

### 10-1 使用 / Cautions

a. 请在额定电压、额定电流内使用温度保险丝。

Use the thermal cutoff with a voltage and current level lower than the rated level.

b. 请勿当作电流保险丝使用。

Don't use this device for and purpose other than as a thermal cutoff.

c. 请勿在水、有机溶剂液体及亚硫酸气体或高湿环境下使用。

Don't use the thermal cutoff in water, organic solvents or other liquids, or environments containing sulfurous acid gas, nirtous acid gas, or high humidity.

### 10-2 引线处理 / Lead wire process

a. 引线进行曲折加工时，请先在离本体 3mm 以上处固定后再进行曲折加工。

The lead wire should be bent at distance 3 mm or more from the body of the fuse.

b. 作业时，不要向引线施加过大的拉力，推力或扭力。

Don't be careful to apply force that may pull, push or twist to the lead wires.

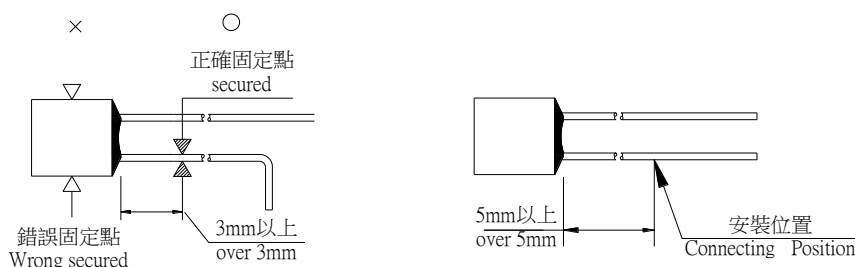



### 10-3 安裝 / Mounting

- a. 溫度保險絲可以用焊接、鉚合等方式進行安裝。

The thermal cutoff can be mounted by soldering, caulking, or welding.

- b. 建議使引線（樹脂封口側）的安裝位置離開本體 5mm 以上。

It is recommended that the connecting position at the lead of resin-sealed side should be 5 mm or more from the body of the thermal cutoff.

- c. 如果是用焊接方式安裝：為防止焊接時的热量引發保險絲動作，在焊接時，建議用散熱夾，夾在保險絲外殼附近，以便热量散發，並在規定的焊錫時間內完成，具體焊錫時間如下表：

If soldering, note that the thermal cutoff may not function because of excessive solder temperature. To prevent such malfunctions, for example, holding the lead near the case by tool is effective for allowing the heat to escape, and the soldering should be done in short interval.

Tf 溫度 Tf Temp.	引線距離 Lead Distance			焊錫條件 Soldering Conditions
	10mm	15mm	20mm	
94°C 以下 / 94°C down	1s	2s	3s	焊錫溫度：300°C Soldering Temperature: 300°C
94°C~100°C	2s	3s	4s	
101°C~130°C	3s	4s	5s	
130°C 以上 / over 130°C	4s	5s	5s	

注意：焊錫後 30 秒內不可進行如拉、扭、彎曲等加工。

Attention: After soldering, wait at least 30 seconds before resoldering, taping, securing, or repositioning the TCO.

- d. 如用鉚接的方法安裝，請勿使連接處電阻過大，以防止通過電流時異常發熱，導致溫度保險絲動作。

If caulking or welding, be careful to keep the resistance value of the connecting section low. If the connecting section has a high resistance value, the passing current may generate an abnormally high temperature that will cause the thermal cutoff to operate.

### 11. 其他使用注意事項 / OTHER NOTICE IN USED

符合本公司可能的其他檔的要求。

It could be in conformance with another file, which made by our company.

**12. 安全认证及编号 / STANDARDS AND APPROVALS**

UL	E212625
VDE	40005863
SEMKO	1811352
CCC	2019010205185659
PSE	JET-2179-32001-2001 (TB102&TB115) JET-2179-32001-2002(TB125&TB130) JET-2179-32001-2003(TB150)

**13. 包装 / PACKING**

散装每胶袋 100 个保险丝

每盒 10 袋共 1000 个保险丝

Bulk 100 pcs/ poly bag

10 poly bags / box, altogether 1000 pcs

**14. 其他 / OTHERS**

14-1 如果在使用中有超出本规格书的要求，必须经由双方协商确认。

In the event that an impropriety is found beyond this specification ,it shall be fixed by mutual agreement between the parties.

14-2 如果本规格书有不适当的情况，必须通过双方协商并由本公司修改。

In the event that an impropriety is found in this specification , WALTER ELECTRONIC CO., LTD. shall amend it by mutual agreement between the parties.

版次	制作	确认	审核
第七版	饶 红	蔡明威	<i>Eris KUO</i>



# IMPROVED CERTIFICATIONS SEARCH TOOL. REGISTER NOW!

[▶ LEARN MORE](#)

## XCMQ2.E212625 Thermal Links - Component

If you notice a change to your XCMQ2 Listing Card, click [here](#) to learn more.

[Page Bottom](#)

### Thermal Links - Component

[See General Information for Thermal Links - Component](#)

#### SUZHOU WALTER ELECTRONIC CO LTD

E212625

Fenhu Technic Development Zone  
Wujiang, Jiangsu 215211 CHINA

Model(s) TB102, TB115, TB125, TB130, TB150, TD102, TD115, TD125, TD130, TE103, TE113, TE116, TE121, TE128, TE139, TE142, TE147, TE152, TE169, TE184, TE185, TE187, TE216, TE240, TE66, TE77, TE87, TE94, TE99, TG103, TG113, TG116, TG121, TG128, TG139, TG142, TG147, TG152, TG169, TG184, TG187, TG240, TG66, TG77, TG87, TG94, TG99

NOTE - All models investigated to UL60691.

Marking: Company name or tradename "Walter" or trademark  and model designation.

[Last Updated](#) on 2018-06-13

[Questions?](#)

[Print this page](#)

[Terms of Use](#)

[Page Top](#)

© 2018 UL LLC

The appearance of a company's name or product in this database does not in itself assure that products so identified have been manufactured under UL's Follow-Up Service. Only those products bearing the UL Mark should be considered to be Certified and covered under UL's Follow-Up Service. Always look for the Mark on the product.

UL permits the reproduction of the material contained in the Online Certification Directory subject to the following conditions: 1. The Guide Information, Assemblies, Constructions, Designs, Systems, and/or Certifications (files) must be presented in their entirety and in a non-misleading manner, without any manipulation of the data (or drawings). 2. The statement "Reprinted from the Online Certifications Directory with permission from UL" must appear adjacent to the extracted material. In addition, the reprinted material must include a copyright notice in the following format: "© 2018 UL LLC".





# IMPROVED CERTIFICATIONS SEARCH TOOL. REGISTER NOW!

[▶ LEARN MORE](#)**XCMQ8.E212625****Thermal Links Certified for Canada - Component**

If you notice a change to your XCMQ8 Listing Card, click [here](#) to learn more.

[Page Bottom](#)**Thermal Links Certified for Canada - Component**

[See General Information for Thermal Links Certified for Canada - Component](#)

**SUZHOU WALTER ELECTRONIC CO LTD**

E212625

Fenhu Technic Development Zone  
Wujiang, Jiangsu 215211 CHINA

Model(s) TB102, TB115, TB125, TB130, TB150, TD102, TD115, TD125, TD130, TE103, TE113, TE116, TE121, TE128, TE139, TE142, TE147, TE152, TE169, TE184, TE185, TE187, TE216, TE240, TE66, TE77, TE87, TE94, TE99, TG103, TG113, TG116, TG121, TG128, TG139, TG142, TG147, TG152, TG169, TG184, TG187, TG240, TG66, TG77, TG87, TG94, TG99

NOTE - All models investigated to UL60691.

Marking: Company name or tradename "Walter" or trademark , model designation and the Recognized

Component Mark for Canada, .

[Last Updated](#) on 2018-06-13

[Questions?](#)[Print this page](#)[Terms of Use](#)[Page Top](#)

© 2018 UL LLC

The appearance of a company's name or product in this database does not in itself assure that products so identified have been manufactured under UL's Follow-Up Service. Only those products bearing the UL Mark should be considered to be Certified and covered under UL's Follow-Up Service. Always look for the Mark on the product.

UL permits the reproduction of the material contained in the Online Certification Directory subject to the following conditions: 1. The Guide Information, Assemblies, Constructions, Designs, Systems, and/or Certifications (files) must be presented in their entirety and in a non-misleading manner, without any manipulation of the data (or drawings). 2. The statement "Reprinted from the Online Certifications Directory with permission from UL" must appear adjacent to the extracted material. In addition, the reprinted material must include a copyright notice in the following format: "© 2018 UL LLC".

## ZEICHENGENEHMIGUNG MARKS APPROVAL

Suzhou Walter Electronic  
Co. Ltd.  
Fenhu Technic Development Zone  
215211 LUXU TOWN, WUJIANG CITY  
Jiangsu  
CHINA

ist berechtigt, für ihr Produkt /  
*is authorized to use for their product*

**Temperatursicherung**  
***Thermal link***

die hier abgebildeten markenrechtlich geschützten Zeichen  
für die ab Blatt 2 aufgeführten Typen zu benutzen /  
*the legally protected Marks as shown below for the types referred to on page 2 ff.*

# A

Geprüft und zertifiziert nach /  
*Tested and certified according to*

DIN EN 60691 (VDE 0821):2017-04; EN 60691:2016  
IEC 60691:2015



VDE Prüf- und Zertifizierungsinstitut GmbH  
VDE Testing and Certification Institute  
Zertifizierungsstelle / Certification

M. Tasotti

VDE Zertifikate sind nur gültig bei Veröffentlichung unter:  
VDE certificates are valid only when published on:

Aktenzeichen: 5000410-1171-0002 / 253361

File ref.:

Ausweis-Nr. 40005863

Blatt 1

Certificate No.

Page

Weitere Bedingungen siehe Rückseite und Folgeblätter /  
*further conditions see overleaf and following pages*

Offenbach, 2003-04-09

(letzte Änderung / updated 2019-01-31)

<http://www.vde.com/zertifikat>

<http://www.vde.com/certificate>

Name und Sitz des Genehmigungs-Inhabers / Name and registered seat of the Certificate holder

Suzhou Walter Electronic Co. Ltd., Fenu Technic Development Zone, 215211 LUXU TOWN, WUJIANG CITY,  
Jiangsu, CHINA

Aktenzeichen / File ref.

5000410-1171-0002 / 253361 / TL3 / EUL

letzte Änderung / updated

2019-01-31

Datum / Date

2003-04-09

Dieses Blatt gilt nur in Verbindung mit Blatt 1 des Zeichengenehmigungsausweises Nr. 40005863.

*This supplement is only valid in conjunction with page 1 of the Certificate No. 40005863.*

## Temperatursicherung

### Thermal link

Typ(en) / Type(s)	Bemessungsschalt- Temperatur Rated functioning temperature	Dauerbetriebstemperatur Holding temperature
<b>TB 102</b>	102 °C	76 °C
<b>TB 115</b>	115 °C	85 °C
<b>TB 125</b>	125 °C	97 °C
<b>TB 130</b>	130 °C	102 °C
<b>TB 150</b>	150 °C	120 °C
Bemessungsspannung Rated voltage	AC 125 V / AC 250 V	
Bemessungsstrom Rated current	2 A	
Max. Grenztemperatur Max. temperature limit	180 °C	
Zur Verwendung in For use in	ohmschen Stromkreisen $\cos \phi > 0,95$ resistive circuits $\cos \phi > 0,95$  induktiven Stromkreisen $0,6 < \cos \phi < 0,95$ inductive circuits $0,6 < \cos \phi < 0,95$	
Art der Montage Method of mounting	Einbau built-in	
Kriechstromfestigkeit Tracking resistance	PTI 250	

Dieser Zeichengenehmigungs-Ausweis bildet eine Grundlage für die EG-Konformitätserklärung und CE-Kennzeichnung durch den Hersteller oder dessen Bevollmächtigten und bescheinigt die Konformität mit den grundlegenden Schutzanforderungen der **EG-Niederspannungsrichtlinie 2014/35/EU**.

*This Marks Approval is a basis for the EC Declaration of Conformity and the CE Marking by the manufacturer or his agent and proves the conformity with the essential safety requirements of the **EC Low-Voltage Directive 2014/35/EU**.*

VDE Prüf- und Zertifizierungsinstitut GmbH

VDE Testing and Certification Institute

Fachgebiet TL3

Section TL3

# VDE Prüf- und Zertifizierungsinstitut Zeichengenehmigung

Ausweis-Nr. / Beiblatt /  
Certificate No. Supplement  
40005863

Name und Sitz des Genehmigungs-Inhabers / *Name and registered seat of the Certificate holder*

Suzhou Walter Electronic Co. Ltd., Fenu Technic Development Zone, 215211 LUXU TOWN, WUJIANG CITY,  
Jiangsu, CHINA

Aktenzeichen / *File ref.*

5000410-1171-0002 / 253361 / TL3 / EUL

letzte Änderung / *updated*

2019-01-31

Datum / *Date*

2003-04-09

Dieses Beiblatt ist Bestandteil des Zeichengenehmigungsausweises Nr. 40005863.

*This supplement is part of the Certificate No. 40005863.*

## Temperatursicherung

### *Thermal link*

### Fertigungsstätte(n)

#### *Place(s) of manufacture*

Referenz/*Reference*  
**30006375**

Dongguan Walter Electric Co., Ltd.  
Yan Tian, Feng Gang Town  
523702 DONGGUAN CITY  
Guangdong  
CHINA

Referenz/*Reference*  
**30011941**

Suzhou Walter Electronic  
Co. Ltd.  
Fenu Technic Development Zone  
215211 LUXU TOWN, WUJIANG CITY  
Jiangsu  
CHINA

VDE Prüf- und Zertifizierungsinstitut GmbH

*VDE Testing and Certification Institute*

Fachgebiet TL3

*Section TL3*

Name und Sitz des Genehmigungs-Inhabers / *Name and registered seat of the Certificate holder*

Suzhou Walter Electronic Co. Ltd., Fenuh Technic Development Zone, 215211 LUXU TOWN, WUJIANG CITY, Jiangsu, CHINA

Aktenzeichen / *File ref.*

5000410-1171-0002 / 253361 / TL3 / EUL

letzte Änderung / *updated*

2019-01-31

Datum / *Date*

2003-04-09

Dieses Blatt gilt nur in Verbindung mit Blatt 1 des Zeichengenehmigungsausweises Nr. 40005863.

*This supplement is only valid in conjunction with page 1 of the Certificate No. 40005863.*

## **Genehmigung zum Benutzen des auf Seite 1 abgebildeten markenrechtlich geschützten Zeichens des VDE:**

Grundlage für die Benutzung sind die Allgemeinen Geschäftsbedingungen (AGB) der VDE Prüf- und Zertifizierungsinstitut GmbH ([www.vde.com\AGB-Institut](http://www.vde.com\AGB-Institut)). Das Recht zur Benutzung erstreckt sich nur auf die bezeichnete Firma mit den genannten Fertigungsstätten und die oben aufgeführten Produkte mit den zugeordneten Bezeichnungen. Die Fertigungsstätte muss so eingerichtet sein, dass eine gleichmäßige Herstellung der geprüften und zertifizierten Ausführung gewährleistet ist.

Die Genehmigung ist so lange gültig wie die VDE-Bestimmungen gelten, die der Zertifizierung zugrunde gelegen haben, sofern sie nicht auf Grund anderer Bedingungen aus der VDE Prüf- und Zertifizierungsordnung (PM102) zurückgezogen werden muss.

Der Gültigkeitszeitraum einer VDE-GS-Zeichengenehmigung kann auf Antrag verlängert werden. Bei gesetzlichen und / oder normativen Änderungen kann die VDE-GS-Zeichengenehmigung ihre Gültigkeit zu einem früheren als dem angegebenen Datum verlieren.

Produkte, die das Biozid Dimethylfumarat (DMF) enthalten, dürfen gemäß der Kommissionsentscheidung 2009/251/EG nicht mehr in den Verkehr gebracht oder auf dem Markt bereitgestellt werden.

Der VDE-Zeichengenehmigungsausweis wird ausschließlich auf der ersten Seite unterzeichnet.

### **Approval to use the legally protected Mark of the VDE as shown on the first page:**

*Basis for the use are the general terms and conditions of the VDE Testing and Certification Institute ([www.vde.com\terms-institute](http://www.vde.com\terms-institute)). The right to use the mark is granted only to the mentioned company with the named places of manufacture and the listed products with the related type references. The place of manufacture shall be equipped in a way that a constant manufacturing of the certified construction is assured.*

*The approval is valid as long as the VDE specifications are in force, on which the certification is based on, unless it is withdrawn according to the VDE Testing and Certification Procedure (PM102E).*

*The validity period of a VDE-GS-Mark Approval may be prolonged on request. In case of changes in legal and / or normative requirements, the validity period of a VDE-GS-Mark Approval may be shortened.*

*Products containing the biocide dimethylfumarate (DMF) may not be marketed or made available on the EC market according to the Commission Decision 2009/251/EC.*

*The approval is solely signed on the first page.*

# Certificate



for European Product Safety

Reference No. 1811352

## Thermal-link for appliances

Type designation TB102, TB115, TB125, TB130 and TB150

Certificate holder **Suzhou Walter Electronic Co., Ltd.**  
**Fenhu Technic Development Zone**  
**Wujiang, Jiangsu**  
**CHINA**

The product complies with the standard(s) EN 60691:2016

Date of expiry 3 September 2023

EU Directive information According to the principle of presumption of conformity, this certificate constitutes support for an EC Declaration of Conformity and CE marking according to the Low Voltage Directive 2014/35/EU.

Additional information in Appendix.

Certification Body Intertek Semko AB, Product Certification

Place Kista - Stockholm

Signed

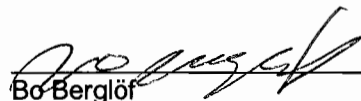
  
Bo Berglör

Date 3 September 2018

Page 1 of 3

This certificate is issued in accordance with the terms and conditions set out in the Appendix.

ABP



# Intertek Appendix

Reference No. 1811352

*Technical data*

Type designation:	TB102	TB115	TB125	TB130	TB150
Rated Voltage (V) <i>Ur</i> :			125/250VAC		
Rated Current (A) <i>Ir</i> :			2A		
Rated functioning temperature <i>Tf</i> :	102°C	115°C	125°C	130°C	150°C
Holding Temperature <i>Th</i> :	76°C	85°C	97°C	102°C	123°C
Maximum temperature limit <i>Tm</i> :	180°C	180°C	180°C	180°C	180°C
Interrupting current (A) <i>Ib</i> :			3A		
Transient overload current (A) <i>Ip</i> :			30A		
Resistant to tracking PTI(V):			> 250		
Brand name:					

*Product information:*

Heat sensitive element – fusible alloy

*Manufacturing site(s)*

Dongguan Walter Electric Co., Ltd  
Yan Tian, Feng Gang Town  
523702 DongGuan City  
Guangdong  
CHINA

Suzhou Walter Electronic Co., Ltd.  
Fenhu Technic Development Zone  
Wujiang, Jiangsu  
CHINA

*This Certificate is for the exclusive use of Intertek's Client and is provided pursuant to the Certification agreement between Intertek and its Client. Intertek's responsibility and liability are limited to the terms and conditions of the agreement. Intertek assumes no liability to any party, other than to the Client in accordance with the agreement, for any loss, expense or damage occasioned by the use of this certificate. Only the Client is authorized to permit copying or distribution of this certificate and then only in its entirety. Use of Intertek's Certification mark is restricted to the conditions laid out in the agreement. Any further use of the Intertek name for the sale or advertisement of the tested material, product or service must first be approved in writing by Intertek. Initial Factory Assessments and Follow up Services are for the purpose of assuring appropriate usage of the Certification mark in accordance with the agreement, they are not for the purposes of production quality control and do not relieve the Client of their obligations in this respect.*

ABF



**Intertek**  
**Appendix**

Reference No. 1811352

According to the principle of presumption of conformity, this certificate, which includes production control, constitutes support for an EC Declaration of Conformity and CE marking according to the Low Voltage Directive 2014/35/EU.

This presumption can expire before end of validity of this certificate due to new issued Standard or Amendment and changes within the EU legislation.

This certificate is based on CB with ref. No. US-31001-A1-UL dated 2018-05-31, issued by UL.

This certificate replaces previously issued ref. No. 1414102 dated 21 November 2014.

A new certificate has been issued on account of renewal of certificate, change of certificate holder and addition of one manufacturing site.

Signed

  
Bo Berglöf

Date 3 September 2018

Certification Body

Intertek Semko AB, Product Certification

Place Kista - Stockholm

*This Certificate is for the exclusive use of Intertek's Client and is provided pursuant to the Certification agreement between Intertek and its Client. Intertek's responsibility and liability are limited to the terms and conditions of the agreement. Intertek assumes no liability to any party, other than to the Client in accordance with the agreement, for any loss, expense or damage occasioned by the use of this certificate. Only the Client is authorized to permit copying or distribution of this certificate and then only in its entirety. Use of Intertek's Certification mark is restricted to the conditions laid out in the agreement. Any further use of the Intertek name for the sale or advertisement of the tested material, product or service must first be approved in writing by Intertek. Initial Factory Assessments and Follow up Services are for the purpose of assuring appropriate usage of the Certification mark in accordance with the agreement, they are not for the purposes of production quality control and do not relieve the Client of their obligations in this respect.*

ASF





# 中国国家强制性产品认证证书

证书编号：2019010205185659

### 委托人名称、地址

苏州华德电子有限公司  
江苏省吴江市汾湖经济技术开发区(芦墟)

### 生产者(制造商)名称、地址

苏州华德电子有限公司  
江苏省吴江市汾湖经济技术开发区(芦墟)

### 生产企业名称、地址

苏州华德电子有限公司  
江苏省吴江汾湖经济开发区新黎路99号

### 产品名称和系列、规格、型号

热熔断体

TB102 Tf:102°C, Th:76°C, Tm:180°C; TB115 Tf:115°C, Th:85°C, Tm:180°C; TB125 Tf:125°C, Th:97°C, Tm:180°C; TB130 Tf:130°C, Th:102°C, Tm:180°C; TB150 Tf:150°C, Th:123°C, Tm:180°C; 125V/ 250V AC 2A 电阻性负载/电感性负载 PFI250

### 产品标准和技术要求

GB/T9816.1-2013

上述产品符合强制性产品认证实施规则 CNCA-C02-01:2014 的要求，特发此证。

发证日期：2019年06月03日 有效期至：2024年06月03日  
证书有效期内本证书的有效性依据发证机构的定期监督获得保持。

本证书的相关信息可通过国家认监委网站 [www.cnca.gov.cn](http://www.cnca.gov.cn) 查询



主任：陆梅



## 中国质量认证中心



# CERTIFICATE FOR CHINA COMPULSORY PRODUCT CERTIFICATION

CERTIFICATE NO.: 2019010205185659

## NAME AND ADDRESS OF THE APPLICANT

Suzhou Walter Electronic Co., Ltd.  
Fenhu Technic Development Zone, Luxu, Wujiang City, Jiangsu

## NAME AND ADDRESS OF THE MANUFACTURER

Suzhou Walter Electronic Co., Ltd.  
Fenhu Technic Development Zone, Luxu, Wujiang City, Jiangsu

## NAME AND ADDRESS OF THE FACTORY

Suzhou Walter Electronic Co., Ltd.  
No.99 Xinli Road, Fenhu Technic Development Zone, Luxu, Wujiang City, Jiangsu

## PRODUCT NAME, MODEL AND SPECIFICATION

Thermal-links

TB102 Tf:102°C, Th:76°C, Tm:180°C; TB115 Tf:115°C, Th:85°C, Tm:180°C; TB125 Tf:125°C, Th:97°C, Tm:180°C; TB130 Tf:130°C, Th:102°C, Tm:180°C; TB150 Tf:150°C, Th:123°C, Tm:180°C; 125V/ 250V AC 2A 电阻性负载/电感性负载 RTI 250

## THE STANDARDS AND TECHNICAL REQUIREMENTS FOR THE PRODUCTS

GB/T9816.1-2013

This is to certify that the above mentioned product(s) complies with the requirements of implementation rules for compulsory certification(REFNO.CNCA-C02-01:2014).

Valid from: Jun.03,2019

Valid until: Jun.03,2024

The validity of the certificate is subject to positive result of the regular follow up inspection by issuing certification body until the expiry date.

The certificate information is available through CNCA's website: www.cnca.gov.cn



President:

Lu Mei



## CHINA QUALITY CERTIFICATION CENTRE

# 適合同等証明書

Statement of Conformity Assessment

電気用品安全法第8条第1項に規定する技術基準及び同法第9条第2項の経済産業省令で定める基準（法第9条第1項第2号に係る検査に係るものに限る）に適合していることを証明します

I hereby certify that the product mentioned below complies with the technical requirements stipulated in Paragraph 1 of Article 8 of Electrical Appliances and Materials Safety Act (here under referred to as the Act) and the requirements defined by the ordinance of the Ministry of Economy, Trade and Industry based on Paragraph 2 of Article 9 of the Act (limited to Item 2 of Paragraph 1 of Article 9 for Inspection of the Act).

1. 証明書番号: JET 2179-32001-2001  
Statement Number
2. 交付年月日: 2019年 6月26日  
Effective Date June 26, 2019
3. 有効年月日: 2026年 6月25日  
Date of Validity June 25, 2026
4. 申込者名 (Applicant)  
住所: FENHU TECHNIC DEVELOPMENT ZONE WUJIANG, JIANGSU PROVINCE, CHINA  
Address

氏名又は名称: SUZHOU WALTER ELECTRONIC CO., LTD.  
Name

5. 特定電気用品名: 温度ヒューズ  
Name of Product Thermal links
6. 型式の区分: 別紙のとおり  
Type Classification See attached "Type Classification"
7. 製造工場名 (Manufacturer)  
住所: FENHU TECHNIC DEVELOPMENT ZONE WUJIANG, JIANGSU PROVINCE, CHINA  
Address

氏名又は名称: SUZHOU WALTER ELECTRONIC CO., LTD.  
Name

8. 適用試験規格: 電気用品の技術上の基準を定める省令の解釈  
Applied Standard for Testing Description of the technical requirements by the METI Ordinance  
別表第十二 J60691 (H28)

Appendix 12 J60691 (H28)

9. 適合性検査の方法: (Testing Method for Conformity Assessment)
  - 1) 試験用の特定電気用品については、電気用品の技術上の基準を定める省令の解釈に定める方法  
With respect to testing for Category A products, the testing method is based on the technical requirements of the description of Electrical Appliances and Materials stipulated in the METI Ordinance.
  - 2) 当該特定電気用品に係る届出事業者又は事業場における検査設備については、電気用品安全法施行規則別表第四の検査設備の欄に掲げる検査設備ごとにそれぞれ同表の技術上の基準の欄に掲げる方法  
With respect to inspection facilities required for Category A products at the factory, Testing Method described in the column of the technical requirements for each inspection facilities in the column of inspection facilities is shown in the Appendix 4 of Enforcement Regulations of the Act.

10. 注意事項

- 1) この適合同等証明書は、提出された試験用の電気用品に関して評価を行った上で交付したものであり、同一の型式の区分にある電気用品について電気用品安全法第8条1項に規定する技術基準適合確認の義務を履行したことを示すものではありません。

This Statement of Conformity Assessment, which is issued on the evaluation of the submitted test-use Electrical Appliances and Materials, does not signify that the Obligation to Comply with Requirements, which is prescribed at Paragraph 1 of Article 8 of the Act, is fulfilled on Electrical Appliances and Materials in the same Type Classification.

- 2) この適合同等証明書は、別紙に記載されている型式の区分の範囲内及び区分の組み合わせについてのみ有効です。

This Statement of Conformity Assessment is valid only for Electrical Appliances and Materials within the Type Classifications and their combination as stated in the attached "Type Classification".

順海科技  
0755-2810001F

一般財団法人 電気安全環境研究所  
Japan Electrical Safety & Environment technology Laboratories (JET)

理事長 薦田 康久  
President Yasuhisa Komoda

東京都渋谷区代々木5-14-12  
(5-14-12, Yoyogi, Shibuya-ku, Tokyo, Japan)

証明書番号 : J E T 2 1 7 9 - 3 2 0 0 1 - 2 0 0 1

# 適合同等証明書別紙

Statement of Conformity Assessment

## 型式の区分

Type Classification

要素 Factor	区分 Classification
定格電圧 Rated voltage	(2) 125Vを超えるもの Exceeding 125V
定格電流 Rated current	(1) 5 A以下のもの 5A or less
公称動作温度 Nominal operating temperature	(3) 100°Cを超え120°C以下のもの Exceeding 100°C, and less than or equal to 120°C
可溶体への通電 Current to fuse element	(1) あるもの Yes
可溶体の主材料 Fuse element materials	(2) すず、鉛及びビスマスの合金以外の合金のもの Alloy other than tin, lead, and bismuth alloy
容器 Container	(1) あるもの With container
端子 Terminals	(2) 線付きのもの Wire lead
可溶体の形状 Shape of fuse element	(3) その他もの Others

順海科技  
0755-28100019

# 適合同等証明書

Statement of Conformity Assessment

電気用品安全法第8条第1項に規定する技術基準及び同法第9条第2項の経済産業省令で定める基準（法第9条第1項第2号に係る検査に係るものに限る）に適合していることを証明します

I hereby certify that the product mentioned below complies with the technical requirements stipulated in Paragraph 1 of Article 8 of Electrical Appliances and Materials Safety Act (here under referred to as the Act) and the requirements defined by the ordinance of the Ministry of Economy, Trade and Industry based on Paragraph 2 of Article 9 of the Act (limited to Item 2 of Paragraph 1 of Article 9 for Inspection of the Act).

1. 証明書番号： J E T 2 1 7 9 - 3 2 0 0 1 - 2 0 0 2  
Statement Number
2. 交付年月日： 2019年 6月26日  
Effective Date June 26, 2019
3. 有効年月日： 2026年 6月25日  
Date of Validity June 25, 2026
4. 申込者名 (Applicant)  
住所 Address: FENHU TECHNIC DEVELOPMENT ZONE WUJIANG, JIANGSU PROVINCE, CHINA

氏名又は名称： SUZHOU WALTER ELECTRONIC CO., LTD.  
Name

5. 特定電気用品名： 温度ヒューズ  
Name of Product Thermal links
6. 型式の区分： 別紙のとおり  
Type Classification See attached "Type Classification"
7. 製造工場名 (Manufacturer)  
住所 Address: FENHU TECHNIC DEVELOPMENT ZONE WUJIANG, JIANGSU PROVINCE, CHINA

氏名又は名称： SUZHOU WALTER ELECTRONIC CO., LTD.  
Name

8. 適用試験規格： 電気用品の技術上の基準を定める省令の解釈  
Applied Standard for Testing Description of the technical requirements by the METI Ordinance  
別表第十二 J60691 (H28)

Appendix 12 J60691 (H28)

9. 適合性検査の方法： (Testing Method for Conformity Assessment)
  - 1) 試験用の特定電気用品については、電気用品の技術上の基準を定める省令の解釈に定める方法  
With respect to testing for Category A products, the testing method is based on the technical requirements of the description of Electrical Appliances and Materials stipulated in the METI Ordinance.
  - 2) 当該特定電気用品に係る届出事業者又は事業場における検査設備については、電気用品安全法施行規則別表第四の検査設備の欄に掲げる検査設備ごとにそれぞれ同表の技術上の基準の欄に掲げる方法  
With respect to inspection facilities required for Category A products at the factory, Testing Method described in the column of the technical requirements for each inspection facilities in the column of inspection facilities is shown in the Appendix 4 of Enforcement Regulations of the Act.

## 10. 注意事項

- 1) この適合同等証明書は、提出された試験用の電気用品に関して評価を行った上で交付したものであり、同一の型式の区分にある電気用品について電気用品安全法第8条1項に規定する技術基準適合確認の義務を履行したことを示すものではありません。

This Statement of Conformity Assessment, which is issued on the evaluation of the submitted test-use Electrical Appliances and Materials, does not signify that the Obligation to Comply with Requirements, which is prescribed at Paragraph 1 of Article 8 of the Act, is fulfilled on Electrical Appliances and Materials in the same Type Classification.

- 2) この適合同等証明書は、別紙に記載されている型式の区分の範囲内及び区分の組み合わせについてのみ有効です。

This Statement of Conformity Assessment is valid only for Electrical Appliances and Materials within the Type Classifications and their combination as stated in the attached "Type Classification".

順海科技  
0755-2810001F

一般財団法人 電気安全環境研究所  
Japan Electrical Safety & Environment technology Laboratories(JET)

理事長 薦田 康久  
President Yasuhisa Komoda

東京都渋谷区代々木5-14-12  
(5-14-12, Yoyogi, Shibuya-ku, Tokyo, Japan)

証明書番号：JET2179-32001-2002

# 適合同等証明書別紙

Statement of Conformity Assessment

## 型式の区分

Type Classification

要素 Factor	区分 Classification
定格電圧 Rated voltage	(2) 125Vを超えるもの Exceeding 125V
定格電流 Rated current	(1) 5 A以下のもの 5A or less
公称動作温度 Nominal operating temperature	(4) 120°Cを超え140°C以下のもの Exceeding 120°C, and less than or equal to 140°C
可溶体への通電 Current to fuse element	(1) あるもの Yes
可溶体の主材料 Fuse element materials	(2) すず、鉛及びビスマスの合金以外の合金のもの Alloy other than tin, lead, and bismuth alloy
容器 Container	(1) あるもの With container
端子 Terminals	(2) 線付きのもの Wire lead
可溶体の形状 Shape of fuse element	(3) その他もの Others

順海科技  
0755-2810001F



# 適合同等証明書

Statement of Conformity Assessment

電気用品安全法第8条第1項に規定する技術基準及び同法第9条第2項の経済産業省令で定める基準（法第9条第1項第2号に係る検査に係るものに限る）に適合していることを証明します

I hereby certify that the product mentioned below complies with the technical requirements stipulated in Paragraph 1 of Article 8 of Electrical Appliances and Materials Safety Act (here under referred to as the Act) and the requirements defined by the ordinance of the Ministry of Economy, Trade and Industry based on Paragraph 2 of Article 9 of the Act (limited to Item 2 of Paragraph 1 of Article 9 for Inspection of the Act).

1. 証明書番号: JET2179-32001-2003  
Statement Number
2. 交付年月日: 2019年6月26日  
Effective Date June 26, 2019
3. 有効年月日: 2026年6月25日  
Date of Validity June 25, 2026
4. 申込者名 (Applicant)  
住所: FENHU TECHNIC DEVELOPMENT ZONE WUJIANG, JIANGSU PROVINCE, CHINA  
Address

氏名又は名称: SUZHOU WALTER ELECTRONIC CO., LTD.  
Name

5. 特定電気用品名: 温度ヒューズ  
Name of Product Thermal links
6. 型式の区分: 別紙のとおり  
Type Classification See attached "Type Classification"
7. 製造工場名 (Manufacturer)  
住所: FENHU TECHNIC DEVELOPMENT ZONE WUJIANG, JIANGSU PROVINCE, CHINA  
Address

氏名又は名称: SUZHOU WALTER ELECTRONIC CO., LTD.  
Name

8. 適用試験規格: 電気用品の技術上の基準を定める省令の解釈  
Applied Standard for Testing Description of the technical requirements by the METI Ordinance  
別表第十二 J60691 (H28)

Appendix 12 J60691 (H28)

9. 適合性検査の方法: (Testing Method for Conformity Assessment)
  - 1) 試験用の特定電気用品については、電気用品の技術上の基準を定める省令の解釈に定める方法  
With respect to testing for Category A products, the testing method is based on the technical requirements of the description of Electrical Appliances and Materials stipulated in the METI Ordinance.
  - 2) 当該特定電気用品に係る届出事業者又は事業場における検査設備については、電気用品安全法施行規則別表第四の検査設備の欄に掲げる検査設備ごとにそれぞれ同表の技術上の基準の欄に掲げる方法  
With respect to inspection facilities required for Category A products at the factory, Testing Method described in the column of the technical requirements for each inspection facilities in the column of inspection facilities is shown in the Appendix 4 of Enforcement Regulations of the Act.

10. 注意事項

- 1) この適合同等証明書は、提出された試験用の電気用品に関して評価を行った上で交付したものであり、同一の型式の区分にある電気用品について電気用品安全法第8条1項に規定する技術基準適合確認の義務を履行したことを示すものではありません。

This Statement of Conformity Assessment, which is issued on the evaluation of the submitted test-use Electrical Appliances and Materials, does not signify that the Obligation to Comply with Requirements, which is prescribed at Paragraph 1 of Article 8 of the Act, is fulfilled on Electrical Appliances and Materials in the same Type Classification.

- 2) この適合同等証明書は、別紙に記載されている型式の区分の範囲内及び区分の組み合わせについてのみ有効です。

This Statement of Conformity Assessment is valid only for Electrical Appliances and Materials within the Type Classifications and their combination as stated in the attached "Type Classification".

順海科技  
0755-2810001F

一般財団法人 電気安全環境研究所  
Japan Electrical Safety & Environment technology Laboratories(JET)

理事長 薦田 康久  
President Yasuhisa Komoda

東京都渋谷区代々木5-14-12  
(5-14-12, Yoyogi, Shibuya-ku, Tokyo, Japan)

証明書番号：JET2179-32001-2003

# 適合同等証明書別紙

Statement of Conformity Assessment

## 型式の区分

Type Classification

要素 Factor	区分 Classification
定格電圧 Rated voltage	(2) 125Vを超えるもの Exceeding 125V
定格電流 Rated current	(1) 5 A以下のもの 5A or less
公称動作温度 Nominal operating temperature	(5) 140°Cを超え160°C以下のもの Exceeding 140°C, and less than or equal to 160°C
可溶体への通電 Current to fuse element	(1) あるもの Yes
可溶体の主材料 Fuse element materials	(2) すず、鉛及びビスマスの合金以外の合金のもの Alloy other than tin, lead, and bismuth alloy
容器 Container	(1) あるもの With container
端子 Terminals	(2) 線付きのもの Wire lead
可溶体の形状 Shape of fuse element	(3) その他もの Others

順海科技  
0755-2810001F

証明書番号 : J E T 2 1 7 9 - 3 2 0 0 1 - 2 0 0 3