

低阻值高功率厚膜贴片电阻承认书-CH 系列

Approval Specification for Low Resistance High Power Thick Film Chip Resistors - Type **CH**

1. 范围 (scope) :

1.1 适用于本公司所生产的无铅、无卤之低阻值高功率厚膜贴片电阻 CH 系列

This specification applies to low resistance high power thick film chip resistors which meet requirements of Pb free and halogen free.

1.2 本公司的无铅产品指的贴片电阻端电极无铅，而存在于电阻层的玻璃中的符合 RoHS 豁免条款。

There no lead exists in terminal of resistor, and lead which exist in glass of resistor layer meets RoHS exemption.

2. 产品料号 (part number) :

1206 1/2W 1% 68mΩ

CH1206F3R068G







<u>CH</u>	<u>1206</u>	<u>F</u>	<u>3</u>	<u>R068</u>	<u>G</u>
类型(Type) CH: 高功率厚膜贴片电阻 (high power thick film chip resistors)	尺寸(Size) 0402 0603 0805 1206 1210 2010 2512	公差 Tolerance F=±1% J=±5%	额定功率 Rated Power 1= 1W 2= 3/4W 3= 1/2W 4= 1/4W 8= 1/8W A= 1/10W B= 2W	阻值 Resistance value <100mΩ(不含) R050=50 mΩ R068=68mΩ ≥ 100mΩ(含) R100=100mΩ R470=470mΩ	包装代码 Packing Code G=7 inch reel 卷装 正常包装 S=10 inch reel 卷装 加倍数量包装 U=13 inch reel 卷装 再加倍数量包装 V= bulk (散料) * 包装数量见10.2包装尺寸及数量



低阻值大功率厚膜贴片电阻承认书-CH 系列

Approval Specification for Low Resistance High Power Thick Film Chip Resistors - Type **CH**

3. 电阻本体字码标示(Marking on the Resistor's Body):

<p>※ 0402 因本体太小，本体上无字码标示。 For 0402 size, no marking on the body due to the small size of the resistor</p> <p>※ 0603 尺寸的产品，以三字码标示，第一位码R 表示10^{-3}，后两位表示阻值的有效数字。 For 0603 size, use three digitals to declare resistance. The first letter 'R' denotes 10^{-3}, The other two digitals declare resistance.</p> <p>※ 0603 以上尺寸的产品，以四字码标示，第一位码R 表示10^{-3}，后三位表示阻值的有效数字。 The size larger than 0603, use four digitals to declare resistance. The first letter 'R' denotes 10^{-3}, The other three digitals declare resistance.</p>	   	<p>R10=R100=0.100 Ω 068=R068=0.068 Ω</p> <hr/> <p>R068=R068=0.068 Ω R330=R330=0.330 Ω</p>
--	---	---

R-value	0805 以上 Code	0603Code	R-value	0805 以上 Code	0603Code	R-value	0805 以上 Code	0603Code
10m Ω	R010	010	100m Ω	R100	R10	360m Ω	R360	R36
20m Ω	R020	020	110m Ω	R110	R11	390m Ω	R390	R39
25m Ω	R025	025	120m Ω	R120	R12	400m Ω	R400	R40
30m Ω	R030	030	130m Ω	R130	R13	430m Ω	R430	R43
40m Ω	R040	040	150m Ω	R150	R15	470m Ω	R470	R47
50m Ω	R050	050	160m Ω	R160	R16	500m Ω	R500	R50
51m Ω	R050	051	180m Ω	R180	R18	510m Ω	R510	R51
56m Ω	R056	056	200m Ω	R200	R20	560m Ω	R560	R56
62m Ω	R062	062	220m Ω	R220	R22	620m Ω	R620	R62
68m Ω	R068	068	240m Ω	R240	R24	680m Ω	R680	R68
75m Ω	R075	075	270m Ω	R270	R27	750m Ω	R750	R75
82m Ω	R082	082	300m Ω	R300	R30	820m Ω	R820	R82
91m Ω	R091	091	330m Ω	R330	R33	910m Ω	R910	R91



低阻值高功率厚膜贴片电阻承认书-CH 系列

Approval Specification for Low Resistance High Power Thick Film Chip Resistors - Type **CH**

4. 尺寸 (dimension) :

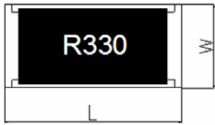
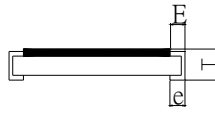
尺寸 dimension					单位 (unit) : mm
	型别 (Type)	L	W	T	
CH0402	1.00±0.05	0.50±0.05	0.30±0.05	0.15±0.10	0.20±0.10
CH0603	1.60±0.10	0.80±0.10	0.45±0.10	0.25±0.20	0.30±0.20
CH0805	2.00±0.15	1.25±0.15	0.50±0.10	0.35±0.20	0.40±0.20
CH1206	3.10±0.15	1.60±0.15	0.55±0.10	0.45±0.25	0.40±0.25
CH1210	3.10±0.15	2.50±0.15	0.55±0.15	0.35±0.25	0.60±0.25
CH2010	5.00±0.20	2.50±0.20	0.55±0.15	0.65±0.25	0.50±0.25
CH2512	6.25±0.20	3.10±0.20	0.55±0.15	0.85±0.25	0.95±0.25

5. 功率衰减曲线 (Derating Curve) :

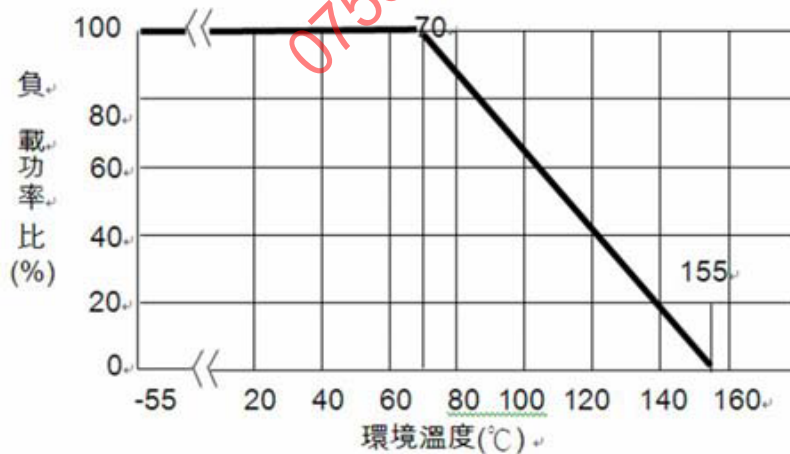

工作温度范围 (Operating Temperature Range) : -55°C~+155°C;

储存条件 (storage condition) : 5~30°C, 30~75%RH.



低阻值大功率厚膜贴片电阻承认书-CH 系列

Approval Specification for Low Resistance High Power Thick Film Chip Resistors - Type **CH**

6.电阻结构 (Construction) :

6.1 电阻结构图: 300mR(含)以下 (Structure: resistance less than or equal to 300mR)

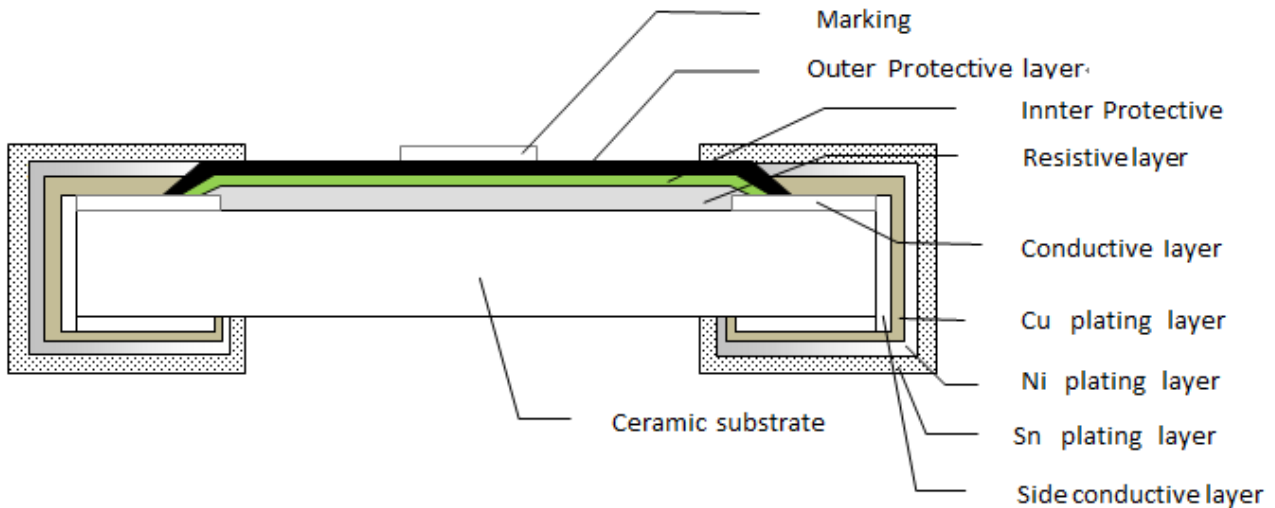

No.	结构 construction	主要材料 Major material
1	陶瓷基板(Ceramic substrate)	三氧化二铝(Al ₂ O ₃)
2	银电极(Conductive layer)	银(Ag)
3	侧电极(Side conductive layer)	镍铬合金(NiCr)
4	阻体层(Resistive layer)	氧化钌+玻璃(RuO ₂ + glass)
5	内保护层(Inner protective layer)	玻璃(Glass)
6	外保护层(Outer Protective layer)	环氧树脂(Epoxy)
7	文字(Marking)	环氧树脂(Epoxy)
8	铜电极(Cu plating layer)	铜(Cu)
9	镍电极(Ni plating layer)	镍(Ni)
10	锡电极(Sn plating layer)	锡(Sn)



低阻值大功率厚膜贴片电阻承认书-CH 系列

Approval Specification for Low Resistance High Power Thick Film Chip Resistors - Type **CH**

6.2 电阻结构图：300mR（不含）以上（Structure: resistance value greater than 300mR）

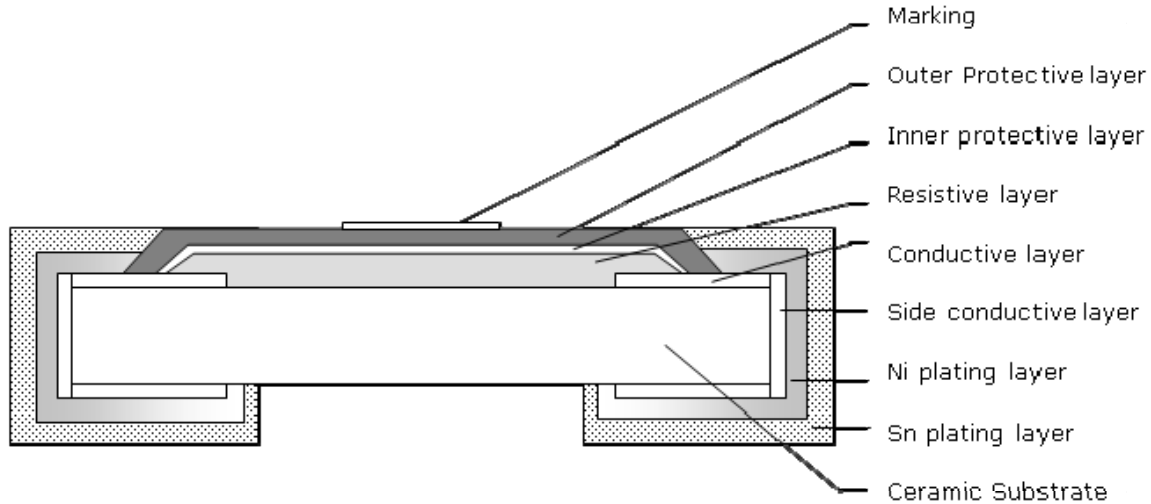

No.	结构 construction	主要材料 Major material
1	陶瓷基板 Ceramic substrate	三氧化二铝 Al ₂ O ₃
2	银电极 Conductive layer	银 Ag
3	侧电极 Side conductive layer	镍铬合金 NiCr
4	阻体层 Resistive layer	氧化钌+玻璃 RuO ₂ + glass
5	内保护层 Inner protective layer	玻璃 Glass
6	外保护层 Outer Protective layer	环氧树脂 Epoxy
7	文字 Marking	环氧树脂 Epoxy
8	镍电极 Ni plating layer	镍 Ni
9	锡电极 Sn plating layer	雾锡 Matte Tin



低阻值大功率厚膜贴片电阻承认书-CH 系列

Approval Specification for Low Resistance High Power Thick Film Chip Resistors - Type **CH**

7. 阻值范围 (resistance range) :

型别 Type	阻值范围 Resistance Range	
	1%	5%
CH0402	0.05Ω~1Ω(不含)	0.05Ω~1Ω(不含)
CH0603	0.05Ω~1Ω(不含)	0.05Ω~1Ω(不含)
CH0805	0.05Ω~1Ω(不含)	0.05Ω~1Ω(不含)
CH1206	0.05Ω~1Ω(不含)	0.05Ω~1Ω(不含)
CH1210	0.10Ω~1Ω(不含)	0.10Ω~1Ω(不含)
CH2010	0.10Ω~1Ω(不含)	0.10Ω~1Ω(不含)
CH2512	0.10Ω~1Ω(不含)	0.10Ω~1Ω(不含)

8. 电气特性(Electrical Characteristics):

型别 Type	CH0402	CH0603	CH0805	CH1206	CH1210	CH2010	CH2512
额定功率 Rated power	1/10W	1/8W	1/4W	1/2W	3/4W	1W	2W
最大工作电流 Max Working Current	1.41A	1.58A	2.24A	3.16A	2.74A	3.16A	4.47A
最大过负荷电流 Max Overload Current	3.54A	3.95A	5.59A	7.91A	6.85A	7.91A	11.18A
绝缘耐压 Dielectric Withstanding Voltage	150V	220V	430V	570V	710V	710V	710V

备注 (remark) :

※ 额定电流计算公式 (The rated current is calculated by the following formula) :

$$I = \sqrt{P/R}$$

I : 额定电流 (Rated current) (A)

P : 额定功率 (Rated Power) (W)

R : 电阻阻值 (Resistance) (ohm)

※ 如果计算出的电流超过此型别的最大工作电流，则此型别的最大工作电流为此电阻的额定电流。

In case the value calculated by the formula exceed the maximum working current as above table 8, the maximum working current shall be regarded as rated current.



低阻值大功率厚膜贴片电阻承认书-CH 系列

Approval Specification for Low Resistance High Power Thick Film Chip Resistors - Type **CH**

9. 信赖性测试 (Reliability Test Methods)

内容 Item	测试方法 Test Methods	测试条件 Test Conditions	规格 Specification
温度系数 Temperature Coefficient	JIS C 5201 4.8	$TCR = (R - R_0) / (t - t_0) R_0 \times 10^6$ (ppm) R_0 电阻在室温下的阻值(resistance at room temperature) R 电阻在 125°C 或 -55°C 下的阻值(resistance at 125°C or -55°C) t_0 室温(room temperature) t 测试温度 (test temperature 125°C or -55°C)	0.05 Ω -0.06 Ω (含): ± 1500PPM/°C; 0.06 Ω -0.1 Ω (含): ± 1000PPM/°C 0.1 Ω -0.5 Ω (含): ± 800PPM/°C; >0.5 Ω: ± 600PPM/°C
焊锡性 Solderability	JIS C 5201 4.17	沾助焊剂后浸入锡炉，锡炉温度 245±5°C，时间 3±0.5 秒。 Dip the terminal in a flux and then dip into a soldering bath at 245±5°C for 3±0.5sec.	最少 95% 面积上锡 (Min 95% coverage)
绝缘电阻 Insulation resistance	JIS C 5201 4.6	电阻本体上加载绝缘耐压 60±5 秒后，测量绝缘阻抗。 Applied the dielectric withstanding voltage on the center of body for 60±5seconds. Then measure insulation resistance.	>10GΩ
绝缘耐压 Dielectric withstanding voltage	JIS C 5201 4.7	电阻本体上加载绝缘耐压 60±5 秒。 Applied the dielectric withstanding voltage on the center of body for 60±5seconds.	无击穿、飞弧及可见机械性损伤 No evidence of flashover, mechanical damage arcing or insulation breakdown
短时间过负荷 Short-time overload	JIS C 5201 4.13	加载 2.5 倍的额定电压，时间 5 秒后测量试验前后的阻值变化率。 Applied 2.5 times of rated voltage for 5 second. Measure the variation of resistance. $\Delta R\% = \frac{R_2 - R_1}{R_1} * 100 \text{-----} (\%)$ R1 = 试验前阻值(resistance before test) R2 = 试验后阻值(resistance after test)	±(2.0% +0.001 Ω)Max



低阻值大功率厚膜贴片电阻承认书-CH 系列

Approval Specification for Low Resistance High Power Thick Film Chip Resistors - Type **CH**

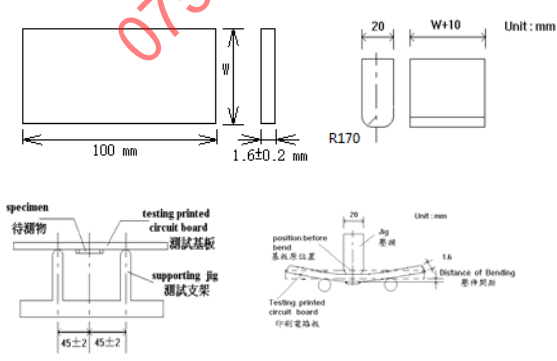
内容 Item	测试方法 Test Methods	测试条件 Test Conditions	规格 Specification
抗焊锡热 Resist to soldering heat	JIS C 5201 4.18	沾助焊剂后浸入锡炉，锡炉温度 260±5℃，时间 10±0.5 秒，测量试验前后的阻值变化率。 Dip the terminal in a flux and then dip into a soldering bath at 260±5℃ for 10±0.5sec. Measure the variation of resistance. $\Delta R\% = \frac{R_2 - R_1}{R_1} * 100 \text{-----} (\%)$ R1 = 试验前阻值(resistance before test) R2 = 试验后阻值(resistance after test)	±(1.0% +0.001 Ω)Max
端子弯曲 Terminal bending	JIS C 5201 4.33	电阻焊接在测试板上进行弯折,弯折保持时间 20±1 秒, 1206(含) 以下的尺寸弯曲 5 ^{+0.2} %mm; 1206 以上的尺寸弯曲 2 ^{+0.2} %mm; 量测试验前后阻值变化率 Specimen shall be mounted on test board, then bend the board and maintained for 20±1s. the distance of bending is 5 ^{+0.2} %mm for resistors which size no larger than 1206 or 2 ^{+0.2} %mm which size larger than 1206. Measure the variation of resistance. 测试板 (test board) 压头 (jig) <div style="text-align: center;">  </div> $\Delta R\% = \frac{R_2 - R_1}{R_1} * 100 \text{-----} (\%)$ R1 = 试验前阻值(resistance before test) R2 = 试验后阻值(resistance after test)	±(2.0% +0.001 Ω)Max



低阻值大功率厚膜贴片电阻承认书-CH 系列

Approval Specification for Low Resistance High Power Thick Film Chip Resistors - Type **CH**

内容 Item	测试方法 Test Methods	测试条件 Test Conditions	规格 Specification
温度循环 Temperature Cycling	JIS C 5201 4.19	电阻放入温度循环机中，温度 155±2℃至-55±3℃，共 5 个循环。 量测试验前后阻值变化率。 Put specimen in a chamber which temperature can be changed to 155±2℃ or -55±3℃, repeated 5 times. Measure the variation of resistance. $\Delta R\% = \frac{R_2 - R_1}{R_1} * 100 \text{-----} (\%)$ R1 = 试验前阻值(resistance before test) R2 = 试验后阻值(resistance after test)	±(2.0% +0.001 Ω)Max
耐湿特性 Humidity	JIS C 5201 4.24	电阻放入恒温恒湿箱，温度 40±2℃，湿度 90~95 %RH;通电额定电压 1.5 小时，断电 0.5 小时；重复通断电至试验时间 1000 ⁺⁴⁸ / ₋₀ 小时。 量测试验前后阻值变化率。 Put the specimen in a chamber at 40±2℃ temperature and 90~95% relative humidity, then applied rated voltage for 1.5H and rested for 0.5H repeatedly till total test time is 1000 ⁺⁴⁸ / ₋₀ .. Measure the variation of resistance. $\Delta R\% = \frac{R_2 - R_1}{R_1} * 100 \text{-----} (\%)$ R1 = 试验前阻值(resistance before test) R2 = 试验后阻值(resistance after test)	±(2.0% +0.001 Ω)Max
负荷寿命 Load life	JIS C 5201 4.25.1	电阻放入恒温箱中，温度 70±2℃，ON TIME:1.5H，OFF TIME:0.5H，通电额定电压 1000 ⁺²⁴ / ₋₀ 小时，量测试验前后阻值变化率。 Put the specimen in a chamber at 70±2℃ temperature, ON TIME:1.5H，OFF TIME:0.5H，and applied rated voltage for 1000 ⁺²⁴ / ₋₀ H. Measure the variation of resistance. $\Delta R\% = \frac{R_2 - R_1}{R_1} * 100 \text{-----} (\%)$ R1 = 试验前阻值(resistance before test) R2 = 试验后阻值(resistance after test)	±(2.0% +0.001 Ω) Max



低阻值大功率厚膜贴片电阻承认书-CH 系列

Approval Specification for Low Resistance High Power Thick Film Chip Resistors - Type **CH**

内容 Item	测试方法 Test Methods	测试条件 Test Conditions	规格 Specification
温湿循环 Moisture resistance	MIL-STD-202 METHOD 106	25 ° C~65 ° C,90~100%RH, 2.5 小时 ; 65 ° C 90~100%RH, 3小时; 65°C~25°C,80~100%RH,2.5 小时,10个循环,试验结束24±4小时后进行测试. 25°C~65°C,90~100%RH, 2.5H; 65°C 90~100%RH, 3H; 65°C~25°C 80~100%RH, 2.5H, 10 cycles, Measurement at 24±4 hours after test conclusion. $\Delta R\% = \frac{R_2 - R_1}{R_1} * 100 \text{-----} (\%)$ R1 = 试验前阻值(resistance before test) R2 = 试验后阻值(resistance after test)	±(2.0% +0.001 Ω)Max

10. 包装规格 (Tapping Specification)

10.1 卷盘尺寸 (reel dimension)

Reel

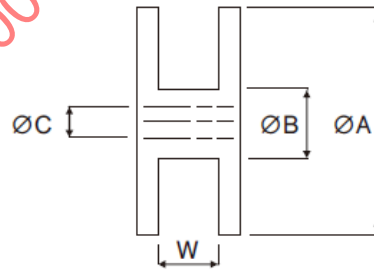

Unit: mm

卷盘及纸带 Reel Type / Tape	Φ A	Φ B	Φ C	W
7 吋卷盘 8mm 纸带 7" reel for 8 mm tape	178±2.0	60.0±1.0	13.5±0.5	9.00±0.3
7 吋卷盘 12mm 纸带 7" reel for 12 mm tape	178±2.0	60.0±1.0	13.5±0.5	13.0±0.3
10 吋卷盘 8mm 纸带 10" reel for 8 mm tape	254±1.0	100.0±1.0	13.5±0.5	10.0±1.0
13 吋卷盘 8mm 纸带 13" reel for 8 mm tape	330±1.0	100.0±1.0	13.5±0.5	10.0±0.5



低阻值大功率厚膜贴片电阻承认书-CH 系列

Approval Specification for Low Resistance High Power Thick Film Chip Resistors - Type **CH**

10.2 包装型别及数量 (Packing Style And Packaging Quantity)

Unit: pcs/reel

产品尺寸 Product Size	7吋卷盘 7 inch reel	10吋卷盘 10 inch reel	13吋卷盘 13 inch reel
CH0402	10,000	20,000	50,000
CH0603	5,000	10,000	20,000
CH0805	5,000	10,000	20,000
CH1206	5,000	10,000	20,000
CH1210	5,000	10,000	20,000
CH2010	4,000	---	---
CH2512	4,000	---	---

10.3 包装尺寸 (Packing Dimension)

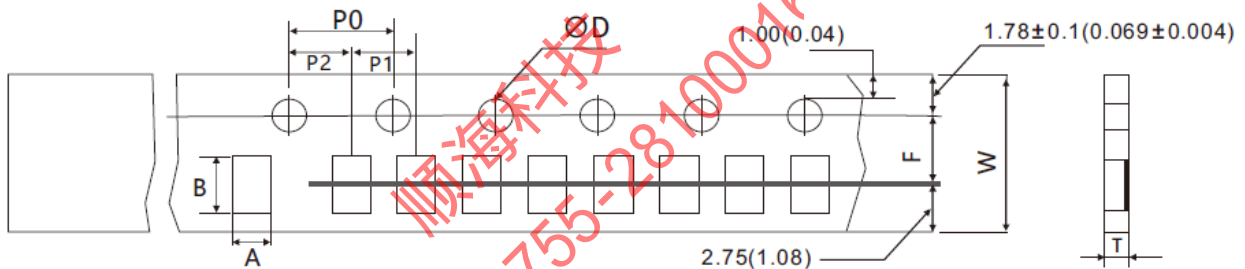

Unit: mm

尺寸 Dimensions	A	B	D	F	P0	P1	P2	W	T
CH0402	0.65±0.10	1.15±0.10	1.50 ^{+0.1} _{0.0}	3.50±0.05	4.00±0.10	2.00±0.10	2.00±0.05	8.00±0.20	0.42±0.07
CH0603	1.10±0.10	1.90±0.10	1.50 ^{+0.1} _{0.0}	3.50±0.05	4.00±0.10	4.00±0.10	2.00±0.05	8.00±0.20	0.60±0.07
CH0805	1.65±0.20	2.40±0.20	1.50 ^{+0.1} _{0.0}	3.50±0.05	4.00±0.10	4.00±0.10	2.00±0.05	8.00±0.20	0.75±0.07
CH1206	2.00±0.20	3.60±0.20	1.50 ^{+0.1} _{0.0}	3.50±0.05	4.00±0.10	4.00±0.10	2.00±0.05	8.00±0.20	0.75±0.07
CH1210	2.80±0.20	3.50±0.20	1.50 ^{+0.1} _{0.0}	3.50±0.05	4.00±0.10	4.00±0.10	2.00±0.05	8.00±0.20	0.75±0.07
CH2010	2.90±0.10	5.30±0.10	1.50 ^{+0.1} _{0.0}	5.50±0.05	4.00±0.10	4.00±0.10	2.00±0.05	12.0±0.10	1.0±0.07
CH2512	3.40±0.10	6.60±0.10	1.50 ^{+0.1} _{0.0}	5.50±0.05	4.00±0.10	4.00±0.10	2.00±0.05	12.0±0.10	1.0±0.07



低阻值高功率厚膜贴片电阻承认书-CH 系列

Approval Specification for Low Resistance High Power Thick Film Chip Resistors - Type **CH**

11. 上胶带剥离力测试 (Peel force of top cover tape)

上胶带以 200mm/分钟的速度，沿 165~180 度角的方向进行剥离，如下图所示。纸带的剥离力范围为 10g~70g；载带的剥离力范围为 15~80g。

The top cover tape is pulled at a speed of 200 mm/min with the angle between the tape during peel and the direction of unreeling maintained at 165 to 180 degree as following picture. The peel force of paper carrier tape shall be 0.1N to 0.7N(10 to 70 g), the peel force of plastic carrier tape shall be 0.15N to 0.80N (15 to 80 g)

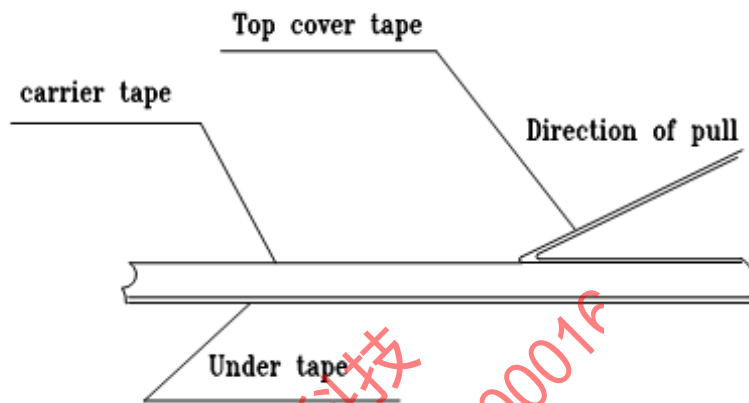

12. 焊盘尺寸 (Recommended land patterns):

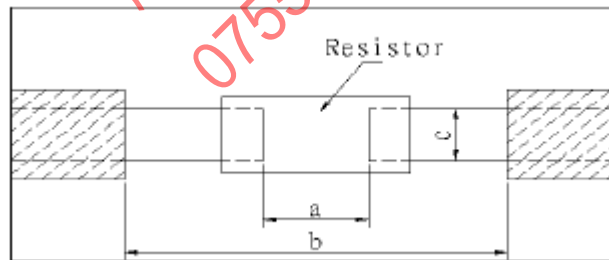

焊盘式样 Land pattern 型别Type	Dimensions (mm)		
	a	b	c
CH0402	0.5~0.6	1.4~1.6	0.4~0.6
CH0603	0.7~0.9	2.0~2.2	0.8~1.0
CH0805	1.0~1.4	3.2~3.8	0.9~1.4
CH1206	2.0~2.4	4.4~5.0	1.2~1.8
CH1210	2.0~2.4	4.4~5.0	2.3~3.5
CH2010	3.3~3.7	5.7~6.5	2.3~3.5
CH2512	3.6~4.0	7.6~8.6	2.3~3.5



低阻值大功率厚膜贴片电阻承认书-CH 系列

Approval Specification for Low Resistance High Power Thick Film Chip Resistors - Type **CH**

13. 焊接 (soldering)

13.1 建议回流焊曲线 (Recommend reflow soldering profile)

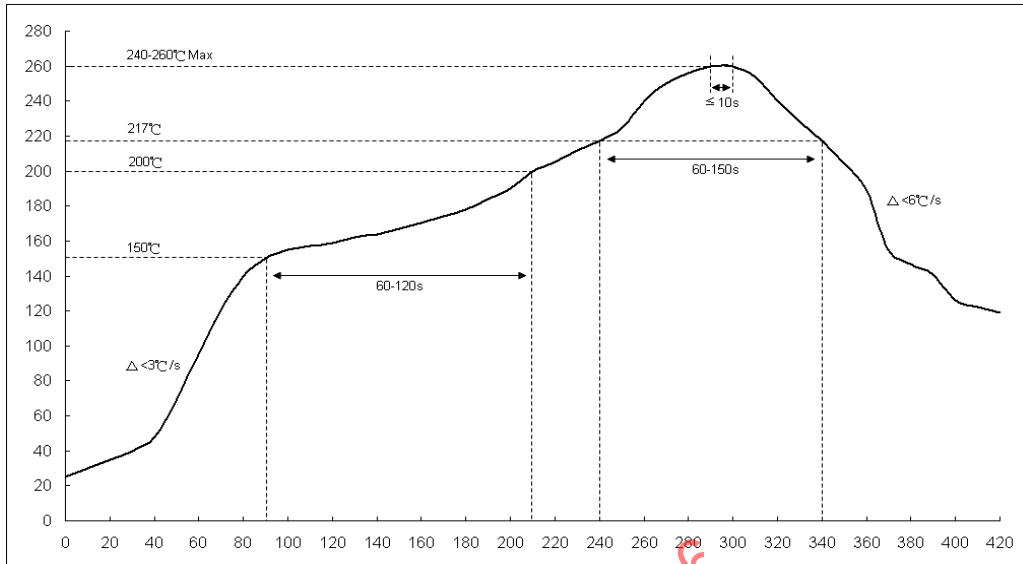

13.2 建议波峰焊曲线 (Recommend wave soldering profile)

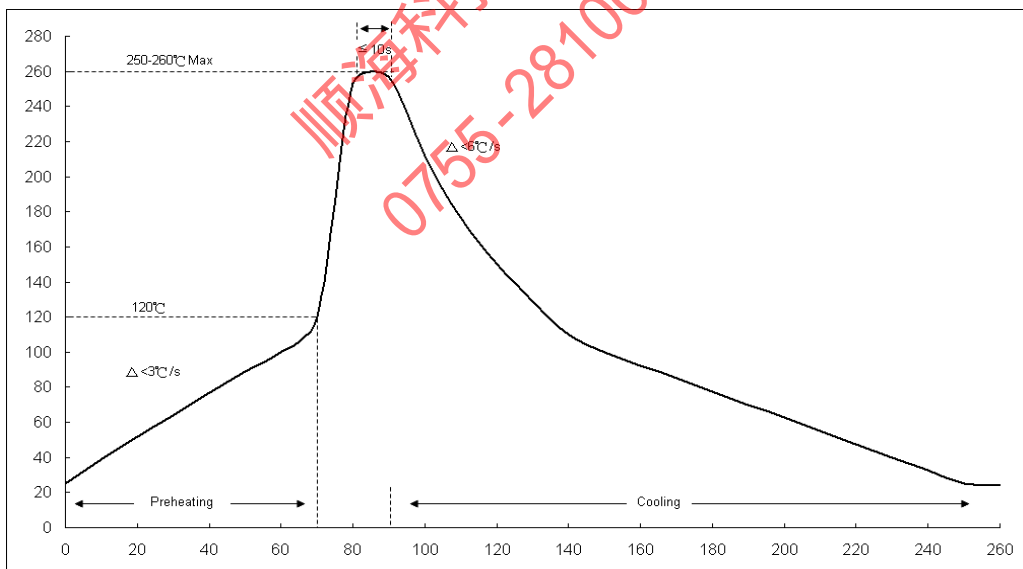

13.3 手工焊温度 (hand soldering temperature)

烙鐵溫度 $350 \pm 10^{\circ}\text{C}$ 3 秒之內，避免烙鐵接觸電阻本體

The iron temperature is $350 \pm 10^{\circ}\text{C}$, hand soldering time less than 3S. Avoid solder iron tip direct touch the components body.

产品规格及资料如有更改，恕不另行通知。

All product specification and data are subject to change without notice